

Uniden®

XDECT SSE47 Series

*For more exciting new products please visit our website:
Australia: www.uniden.com.au*

OWNER'S MANUAL

IMPORTANT SAFETY INSTRUCTIONS

When using your telephone equipment, basic safety precautions should always be followed to reduce the risk of fire, electric shock and injury to persons, including the following:

- **This unit is NOT waterproof.** DO NOT expose this unit to moisture.
- DO NOT expose this unit to rain.
- Do not use this product near water, for example, near a bath tub, wash bowl, kitchen sink or laundry tub, in a wet basement or near a swimming pool.
- Avoid using a telephone (other than a cordless type) during an electrical storm. There may be a remote risk of electric shock from lightning.
- Do not use the telephone to report a gas leak in the vicinity of the leak.
- Use only the power cord and batteries indicated in this manual. Do not dispose of batteries in a fire. They may explode. Check with local codes for possible special disposal instructions.
- Do not place the handset in any charging cradle without the battery installed and the battery cover securely in place.

SAVE THESE INSTRUCTIONS!

General Notices for New Zealand Model:

- The grant of a NZ Telepermit for any item of terminal equipment indicates only that Telecom has accepted that the item complies with minimum conditions for connection to its network. It indicates no endorsement of the product by Telecom, nor does it provide any sort of warranty. Above all, it provides no assurance that any item will work correctly in all respects with another item of Telepermitted equipment of a different make or model, nor does it imply that any product is compatible with all of Telecom's network services.
- The maximum volume setting of this telephone exceeds the Telecom specified volume requirement. Telecom takes no responsibility for the high volume available on this telephone, who believe this telephone is too loud should contact the manufacturer at the website indicated on owner's manual warranty page.
- For telephone networks other than Telecom there may be a charge incurred for local calls if the Insert 0 feature is on. Turn Insert 0 off.
- This equipment may not provide for the effective hand-over of a call to another device connected to the same line.

WHAT'S IN THE BOX?

SSE47 base with answering system, mounting bracket and corded handset



Base AC adaptor (AAD-041S(R))

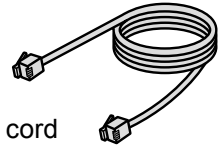
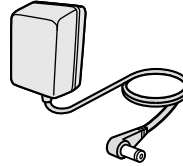

Telephone cord

You will also find:



SSE07 accessory handset and charger

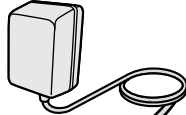

AC Adaptor (AAD-600S(R))

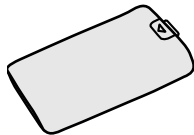

Battery Cover

If you purchased model number:	You should have
SSE47	None
SSE47+1	1 of each
SSE47+2	2 of each
SSE47+3	3 of each
SSE47+4	4 of each
SSE47+5	5 of each



Belt Clip

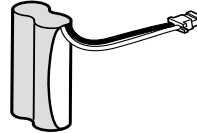

Rechargeable Battery Pack (BT-694, BT-694s or BT-694n)

- If any item is missing or damaged, contact your place of purchase immediately. Never use damaged products!
- Need help? Get answers at our website: www.uniden.com.au

CONTENTS

INSTALLING YOUR PHONE	6
Power Backup (Battery Installation)	8
GETTING TO KNOW YOUR PHONE	10
Parts of the Base	10
Parts of the Handset	12
USING THE MENUS	15
Messages Menu	15
Recent Calls Menu	16
Intercom Menu	16
Base Setup/Handset Menu	16
Date & Time Menu	17
Advanced Setup Menu	17
Entering Text on Your Phone	18
USING YOUR PHONE	19
Change the Volume	19
Using Caller ID and Call Waiting	20
Using the Phonebook	22
Chain Dialing	22
Speed Dial/3 Picture Keys	23
HELP FEATURE	24
Record Emergency Message	24
Editing the SOS Entries in the Phonebook	24
Make an Emergency Call	25
USING SPECIAL FEATURES	26
Real Time Slow Talk	26
Playback Slow Talk	26
Using Caller Announce	26
Call Blocking	27
Adjusting the Base Visual Ringer	28
Using the Audio Boost	28
DND (Do Not Disturb) Mode	28
Using Multi-Handset Features	29
Finding a Lost Handset	30
Using Voice Message Notification	30
Using an Optional Headset	31
USING THE ANSWERING SYSTEM	32
Answering System Options (Answering Setup)	32
Accessing the Answering System	32
Recording Your Personal Greeting	33

Getting Your Messages	34
Screening Your Calls	34
Using the System While You're Away from Home	35
REMINDER SETUP	36
Reminder Messages	36
IMPORTANT INFORMATION	37
Solving Problems	37
Resetting Base/Handset	39
Registering a Handset	39
Adaptor and Battery Information	40
INDEX.....	41
ONE-YEAR LIMITED WARRANTY	42

INSTALLING YOUR PHONE

Your telephone base is ready for desktop use from the factory. If you want to mount your telephone on a wall, follow the guide on page 6.

For Desktop Use

1. Connect the base AC adaptor to the power jack and the telephone cord to the TEL LINE jack. Route the cords as shown below:

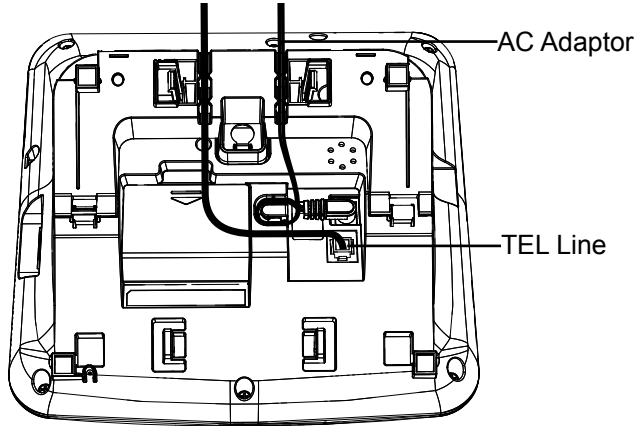

2. Plug the AC adaptor into a standard 240V AC power outlet, and connect the telephone cord to a standard telephone wall jack.
3. Connect the **Corded Handset**, by using the coiled cord, to the connector on the left side of the base.

For Wall Mount Use

1. Press the latches at the top of the stand to release its position.
2. Flip the stand by till it locks into place as shown below:

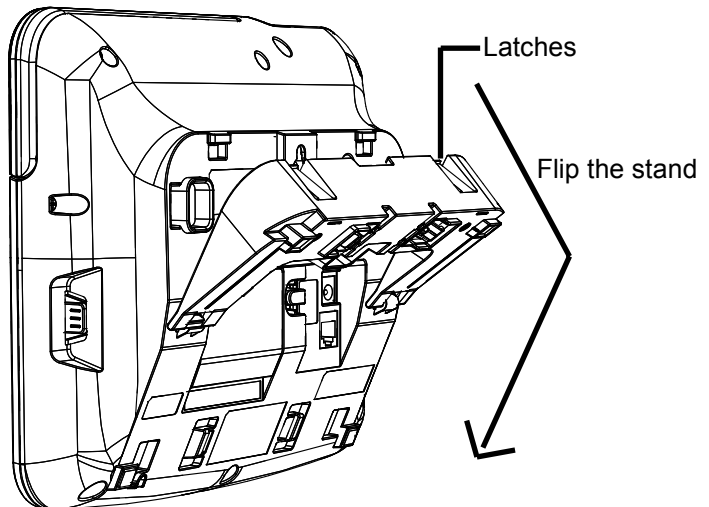

3. Connect the base AC adaptor to the power jack and the telephone cord to the TEL LINE jack. Route the cords as shown below:

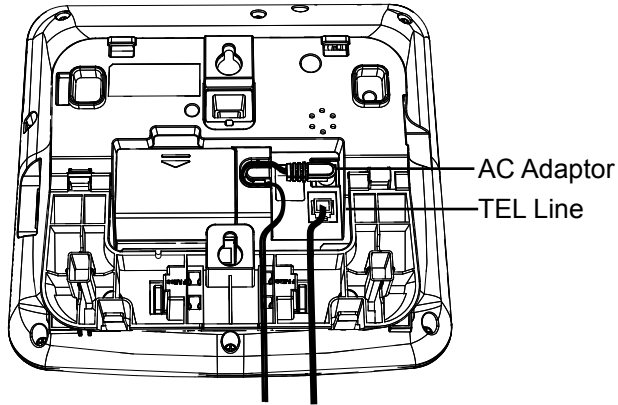

4. Plug the AC adaptor into a standard 240V AC power outlet, and connect the telephone cord to a standard telephone wall jack.
5. On the front of the base, slide the Handset Clip out of its slot.
6. Rotate the Handset Clip 180 degrees.
7. Flip it from front to back and make sure the arrow is pointing downwards to slide it back into the slot.

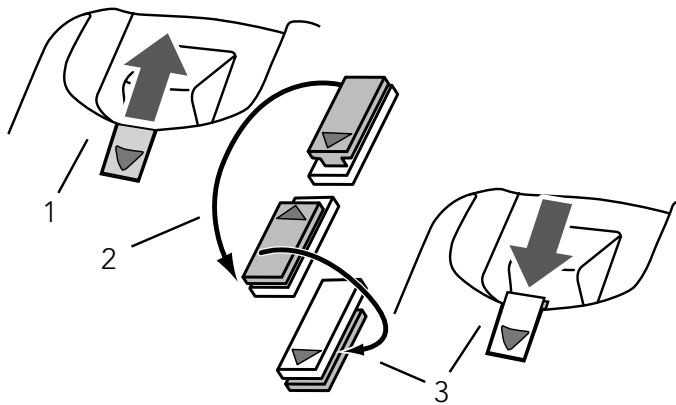

8. Connect the **Corded Handset**, by using the coiled cord, to the connector on the left side of the base.

Select the Country

Select Country menu appears the first time you power on the SSE47 base. Select the country where you will use the phone.

1. Use **VOL UP** or **DOWN** to highlight Australia or New Zealand, then press **MENU/OK**.
 2. The base configures its settings for the selected country, and it returns to standby.
Once you select the country, *Select Country* menu will not appear when the power is on.
- ✎ **If you select the wrong country and you need to try again, use Factory Reset menu option in the Base Setup menu (see page 17).**

Test the Connection

Pick up the corded handset from the base. You should hear a dial tone and the display on the base should say *Talk*. When you get a dial tone, make a quick test call.

If...	Try...
the display shows <i>Check Tel Line</i> or you don't hear a dial tone.	checking the connection between the base and the phone jack.
There's lot of noise or static	See page 37 for tips on avoiding interference.

Using Your Phone During a Power Failure

In the event of a power failure, you can still make and receive phone calls using the SSE 47 base corded handset, with features, including Call Waiting and changing the earpiece volume. However, all other features of the base and all cordless handsets will not function.

- ✎ **While the power is out, the base uses a special ringer; you cannot adjust the volume of this ringer.**

Power Backup (Battery Installation)

You can also insert 3 AAA Alkaline batteries (not supplied) into the base unit, to temporarily help power the unit.

- ✎ **Do not use Ni-MH rechargeable batteries.**
1. Disconnect the telephone line cord and the AC adaptor.
 2. Turn the phone over on to its base to locate and open the battery cover.
 3. Install the AAA Alkaline batteries in the battery compartment (ensure correct polarity).
 4. Close the cover then reconnect the telephone line cord and AC adaptor.
- ✎ **If your telephone service provider requires a modem to make and receive calls, then though the base unit's backup power feature is functioning, you may not be able to make or receive calls.**

Set Up the Accessory Handset(s)

Install and Charge the battery

1. Unpack all handsets, battery packs, and battery covers. If you need to remove a cover, press in on the notch and slide the cover down and off.
 2. Line up the battery connector with the jack inside the handset; the connector only fits one way.
 3. Push the connector in until it clicks into place; tug gently on the wires to make sure the battery is securely connected.
 4. Replace the battery cover and slide it into place.
 5. Use an AC adaptor to connect the power jack on the base to a regular indoor (240V AC) power outlet.
 6. Place each handset in the base with the display facing forward. If the battery icon does not begin cycling through levels, reset the handset or connect the base to a different outlet.
- 🔊 **Charge all handsets completely (about 15 hours) before using.**

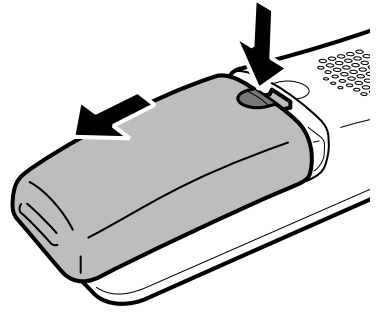

Test the Connection

7. Pick up each handset and press **TALK/FLASH**. You should hear a dial tone, and the display should show *Talk*. (Press **TALK/FLASH** or **END/CLEAR** again to hang up.)
8. If there is noise or static, refer the section, '*There's a lot of noise or static on the line*' on page 37 for tips on avoiding interference.

Using the Belt Clip

To attach the belt clip

1. Line up the holes on each side of the handset.
2. Insert the belt clip into the holes on each side of the handset.
3. Press down until it clicks.

To remove the belt clip

Pull either side of the belt clip to release the tabs from the holes.







GETTING TO KNOW YOUR PHONE

Parts of the Base

Front View







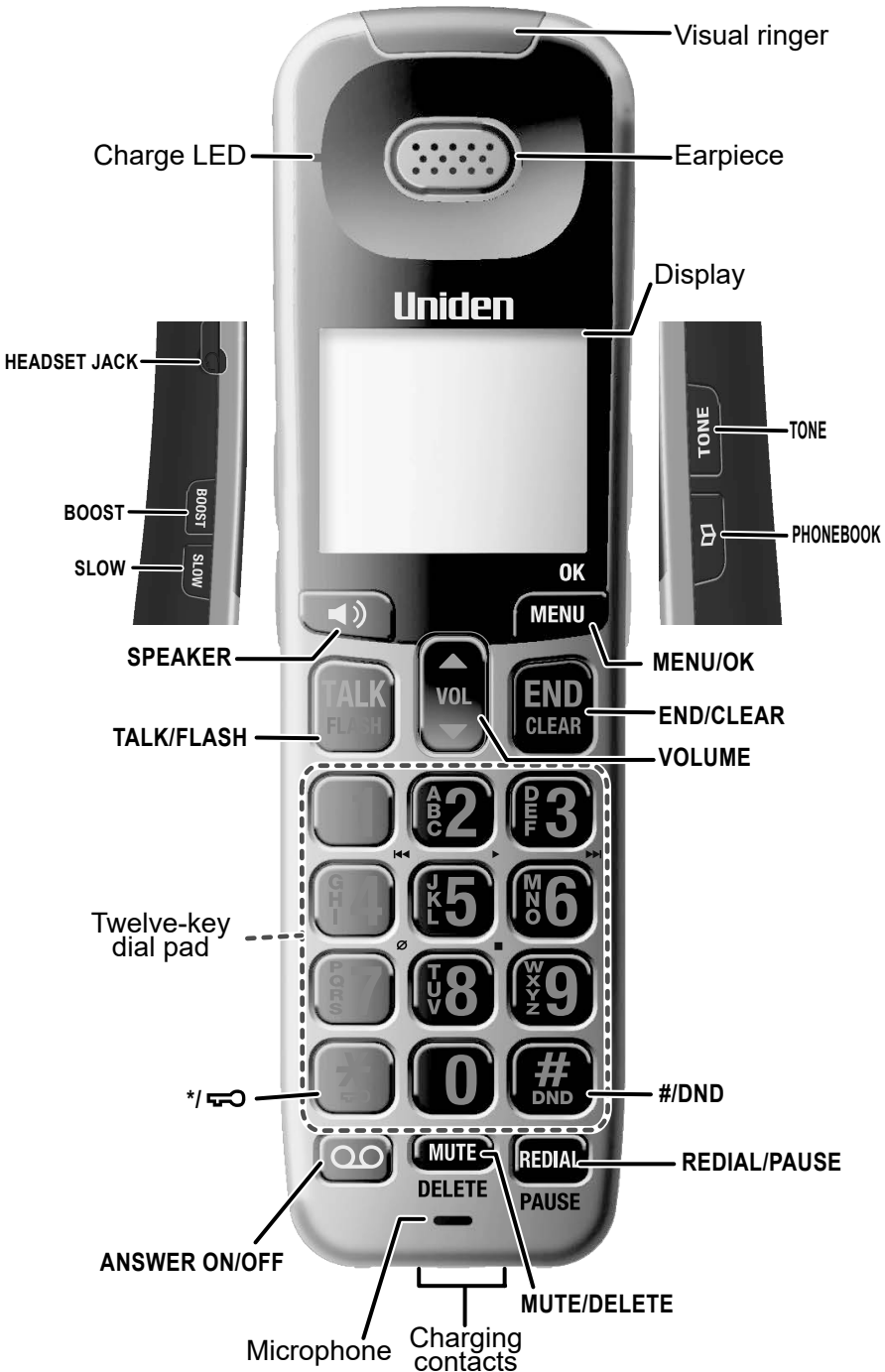

Key Icon	What it does
INT'COM/HOLD	<ul style="list-style-type: none"> In standby: page all handsets so you can find a lost one.
CLEAR/MUTE	<ul style="list-style-type: none"> During a call: mute the microphone. While the phone is ringing: ignore this call (mute the ringer). While entering text: delete the last character, or press and hold to delete all the characters.
MENU/OK	<ul style="list-style-type: none"> In standby: open the menu. In a menu list: select the highlighted submenu.
PHONEBOOK 	Press to display the phonebook menu options.

UP/DOWN 	<ul style="list-style-type: none"> • In standby: increase/decrease the ringer volume • During a call or while a message is playing: increase/decrease the volume. • In any menu or list: move the cursor up/down one line
PICTURE KEY	Speed Dial Keys - Picture Key 1, Picture Key 2, Picture Key 3
REPEAT 	<ul style="list-style-type: none"> • In the first 2 seconds of a message: go to the previous message. • Anytime after that: go back to the beginning of this message.
PLAY/STOP 	<ul style="list-style-type: none"> • In standby: start playing new messages • While a message is playing: stop playing messages
SKIP 	<ul style="list-style-type: none"> • While a message is playing: skip to the next message.
DELETE 	<ul style="list-style-type: none"> • In standby: press to access Delete All menu; press DELETE again to confirm. • While a message is playing: delete this message. • When outgoing greeting is playing: delete the greeting.
SLOW	<ul style="list-style-type: none"> • During message playback: reduce the speed of the answering system playback by 30%. • Real Time: During a call, press to slow down the speed of the other party's voice.
ON/OFF	In standby: turn the answering system on or off.
#/DND	In standby: press and hold to turn DND Mode on or off (see page 28).
BOOST	During a call: increases earpiece volume (see page 28).
FLASH	<ul style="list-style-type: none"> • During a call: switch to a waiting call. • When screening calls: pick up the call. • In a list: dial the selected number. • When in Hold mode: releases hold.
TONE	In Talk or Intercom mode: change audio tone setting; cycles through the following: <ul style="list-style-type: none"> - Natural Tone - High Tone - Low Tone
HELP	Press to dial emergency number
REDIAL/PAUSE	<ul style="list-style-type: none"> • In standby: display the redial history. • When dialing a number: enter a 3-second pause. • When entering or editing a number into the phonebook: Enter a 3-second pause.
SPEAKER 	Switch a normal call to the speakerphone (and back).

Parts of the Handset



 **Visual Ringer:** Flashes to indicate an incoming call.
Flashes to indicate a message in the unit's answering system.

Key Icon	What it does
TONE	During a call: adjust the audio tone (see page 37).
MENU/OK	<ul style="list-style-type: none"> • In standby: open the menu. • In any menu or list: select the highlighted item.
PHONEBOOK 	Press to display the phonebook menu options.
END/CLEAR	<ul style="list-style-type: none"> • During a call: hang up. • In any menu or list: exit and go back to the previous operation. • While entering text: delete the last character, or press and hold to return to Standby.
#/DND	<ul style="list-style-type: none"> • When entering text: insert a space. (See page 18.) • When in standby mode: press and hold for 2 seconds to display the DND Mode menu. (See page 28 for details.)
REDIAL/PAUSE	<ul style="list-style-type: none"> • In standby: open the redial list. • During a phone number entry: insert a 3 second pause. • When entering or editing a number into the phonebook: Enter a 3-second pause.
MUTE/DELETE	<ul style="list-style-type: none"> • When an incoming call is ringing: mute the ringer. • During a menu operation: delete indicated text or item. • When entering text on your phone: delete text the left of the cursor. Press and hold to delete the entire entry.
BOOST	During a call: boost the volume of the earpiece (see page 28).
SPEAKER 	<ul style="list-style-type: none"> • In standby: start a telephone call (get a dial tone). • During a call: will return to earpiece speaker. • When screening calls: pick up the call. • In a list: dial the selected number. • When in Hold mode: release Hold.
SLOW	During message playback: reduce the speed of the answering system playback by 30%. Real Time: During a call, press to slow down the speed of the other party's voice.
TALK/FLASH	<ul style="list-style-type: none"> • In standby: start a telephone call (get a dial tone). • During a call: switch to a waiting call.
*/ 	<ul style="list-style-type: none"> • In text edit mode: changes upper and lower case. • Press and hold to lock or unlock keypad
OO ON/OFF	Turn the Answering system on and off.
VOL UP 	<ul style="list-style-type: none"> • In standby: increase the ringer volume. • During a call: increase the volume. • In any menu or list: move the cursor up one line.
VOL DOWN 	<ul style="list-style-type: none"> • In standby: decrease the ringer volume. • During a call: decrease the volume. • In any menu or list: move the cursor down one line.

Reading the Display

On the Base



On the Handset



Icon	What it means
ANS ON	Answering system status.
	The volume of the earpiece is boosted (see page 28).
	Telephone Answering Device (TAD) or Answering System is on.
	The ringer is turned off: this handset/base will not ring when a call comes in. (To turn on the ringer, with the phone on standby, press the VOL UP ▲ key. The icon disappears and the handset/base will now ring when a call comes in.)
	You have a voice mail message waiting (see page 30). This indicates a message in your Voice Mail (which is a service provided by your phone service provider), not in your unit's answering system.
	T-coil mode is on.
	The battery is 1) fully charged, 2) half charged, 3) getting low, or 4) empty.
	Privacy Mode is on: no other handset can use the line or join your call.
	Energy saving mode is on (transmission power reduced).
	The speakerphone is on.
	A reminder message has been set.

USING THE MENUS

Your phone displays different menus depending on whether you are on-hook or off-hook. Off-hook menus are *Hold/Transfer*, *Recent Calls*, and *Call Privacy*. *Hold/Transfer* and *Call Privacy* are unique to off-hook menus but *Recent Calls* is common to both off-hook and on-hook menus

OK
MENU To open the menu, press MENU/OK on the handset (or MENU on the base).

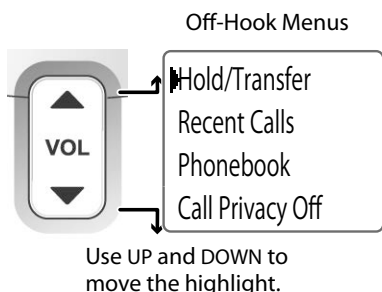

To select the highlighted option, press MENU/OK (or OK on the base).

OR

To close the menu, press END/CLEAR.

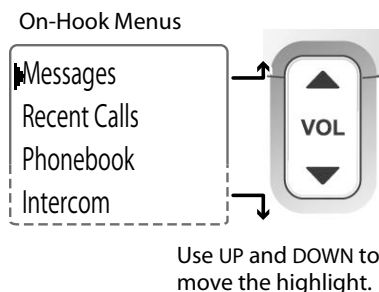

- The phone exits the menu after 30 seconds if no keys are pressed.
- Press **END/CLEAR** during a call to back out of a menu without hanging up.

Hold/Transfer Menu (Off-Hook Menu Only)

This menu option only displays when you are off-hook or on a call. Press **MENU/OK** on the handset, **INTERCOM/HOLD** on the base, or **MENU/OK** and select *Hold/Transfer* on the base. The *Hold/Transfer* menu displays, letting you put a call on hold and page a specific handset or base to transfer the call to or page the base and all the handsets.

Call Privacy Menu (Off-Hook Menu Only)

This menu lets you turn Call Privacy on and off. With Call Privacy turned on, no other handsets can connect with your conversation. Going on-hook (ending your conversation) resets Call Privacy to off.

Messages Menu

Press **MENU/OK** and select *Messages*. You can select *Play Message* (from your answering system) or *Voice Mail* (from your provider's voice mail service).

Answering System Messages

When you select *Play Messages* from the Messages menu, the system announces the number of incoming messages stored and begins playing them back. See page 32 for details.

Voice Mail Messages

When you select *Voice Mail* from the Messages menu, the system automatically dials the voice mail access number you entered. If you have not set one up, then the *Edit V-mail No.* screen displays. You can enter your phone service provider's voice mail access number and press **MENU/OK** to confirm. You could also go to the *Advanced Setup* menu and select the option *Edit Voicemail*, to enter or edit the voice mail access number.

Recent Calls Menu

The Recent Calls menu lets you view the Caller ID list (up to 50) or the Redial list, a list of the last 10 calls made from that handset.

Intercom Menu

The Intercom feature allows 2-way communication between BASE-HAND or HAND-HAND. For more information, see page 30.

Menu Option	What it does
<i>All</i>	Pages all handsets.
<i>Handset</i>	Lists the handsets available for paging.
<i>Base</i> displays on the Handset menu so you can page the base as well.	

Base Setup/Handset Menu

Most of the menu entries for setting up your base and handset are the same. Differences are noted in the menu option itself.

Menu Option	What it does
<i>T-coil (Handset Only)</i>	Turn on T-coil mode to reduce noise on hearing aids equipped with a telecoil (T-coil) feature. T-coil mode shortens talk time, so keep your battery fully charged.
<i>Ringer Tones</i>	Choose this handset's ring tone. As you highlight each ring tone, you hear a sample. To confirm, press MENU/OK .
<i>Personal Ring</i>	Turn on personal ring so you can assign a special ring tone to people in your phonebook. With Caller ID, this handset uses the assigned tone when the person calls.
<i>Auto Talk (Handset Only)</i>	Have this handset answer a call when you pick it up from the cradle (without pressing any keys).
<i>Any Key Answer (Handset Only)</i>	Have this handset answer a call when you press any key on the 12-key dialpad.
<i>Banner (Handset Only)</i>	Change the name used on the handset's display.
<i>Key Touch Tone</i>	Have your keypad sound a tone when you press a key.
<i>LCD Contrast</i>	Choose the contrast of the display from ten different levels.
<i>Caller Announce</i>	Turn on the Text-To-Speech (TTS) feature (see page 26).
<i>PB Announce (Base only)</i>	Turn on to have the system announce phonebook entries as you select them.
<i>Dial Announce (Base speaker only)</i>	Turn on to have the system announce the phone number you are dialing. (For this feature to work, ensure that the receiver is on-hook, while dialing out from the base)

<i>Factory Reset (Base Only)</i>	Reset all data to factory settings. (All stored data will be deleted in this case.)
--------------------------------------	--

Answering Setup Menu

Refer to page 32 for details on setting up your answering system.

Reminder Setup Menu

Refer to page 36 for details on setting up your reminder system.

Date & Time Menu

You need to set the clock so messages get the correct time stamp. Setting the date and time on the base or any handset will set it on all handsets/bases.

When you select *Date & Time*, the system displays the date and time with the first digit of the date flashing. Use the 0 - 9 keys to enter the date and time. When you enter a number, the cursor moves to the next position. Press **VOL UP** to move to the the previous position or **VOL DOWN** to accept the current entry and move to the next position. Press **MENU/OK** to accept the date and time you just entered.

Advanced Setup Menu

The settings on this menu affect all the handsets and the base. Only one handset at a time can change these settings.

Menu Option	What it does
<i>Set Line Mode</i>	Do not change this setting unless instructed to by customer service.
<i>VWMI Reset</i>	Reset the Visual Message Waiting Indicator (see page 30).
<i>Edit Voice Mail</i>	Enter or edit your phone service provider's voice mail access number (see page 15).
<i>Insert 0</i>	This feature adds "0" or "00" at the beginning of the number received from Caller ID. The default setting for New Zealand is <i>On</i> . The default setting for Australia is <i>Off</i> .
<i>Time Adjustment</i>	Select Set by Caller ID to allow phone network to automatically set cordless phone system time.

Call Blocking Menu

See page 27 for a detailed description of the Call Blocking feature.

Register Accy. Menu

Register any additional accessories (See page 39 for details).

Entering Text on Your Phone

Use the 12-key dial pad anytime you want to enter text into your phone (a name in the phonebook, the handset banner, etc.).

If two letters in a row use the same key, enter the first letter, wait for the cursor to move to the next space and enter the second letter.

To...	Press...	To...	Press...
move the cursor left	UP	move the cursor right	DOWN
erase the character at the cursor	CLEAR. *	erase the entire entry	and hold CLEAR. *
switch between upper and lower case letters	*	enter a blank space	#DND
		enter a symbol	0 repeatedly

***END/CLEAR** on the handset or **CLEAR/MUTE** on the base.

* *On the base. */ on the cordless handset.

USING YOUR PHONE

To...	From the base		From a cordless handset	
	Corded Handset	Speaker	Earpiece	Speaker
make a call, dial the number, then	Pick up the handset.	Press SPEAKER .	Press TALK/FLASH .	Press SPEAKER .
answer a call	Pick up the handset.	Press SPEAKER .	Press TALK/FLASH .	Press SPEAKER .
hang up	Place the handset in the cradle.	Press SPEAKER .	Press END/CLEAR or place the handset in the cradle.	
ignore the call (mute the ringer)	Press CLEAR/MUTE while the phone is ringing.		Press MUTE/DELETE while the phone is ringing.	
switch to/from the speaker	Press SPEAKER .	Pick up the handset.	Press SPEAKER .	
mute the microphone	Press CLEAR/MUTE .		Press MUTE/DELETE .	
	Press again to turn the microphone back on.			
put a call on hold	Press INTERCOM/HOLD . *		Press MENU/OK and select <i>Hold/Transfer</i> .*	
return to a call on hold	Quickly press and release the hook switch.	Press SPEAKER .	Press TALK/FLASH .	Press SPEAKER .

• After 2 min 50 sec on hold, the call will be disconnected.

Change the Volume

You can adjust each station's volume independently. Press **UP** or **DOWN** to increase or decrease the earpiece or speaker volume when you are on a call. You can adjust the ringer volume only when the phone is in standby. Turning the ringer volume all the way down turns off the ringer.

☒ **If you want to change the volume of Caller ID announcements, change the ringer volume.**

Using Caller ID and Call Waiting

Caller ID (CID) is a service available from your telephone provider that shows the phone number (and sometimes the caller's name) of the incoming calls; if you turned on Text-To-Speech, it also announces the name. Contact your telephone provider for more information.

Caller ID List	Redial List
<ul style="list-style-type: none"> • The phone saves the information for the last 50 received calls to the CID list. An asterisk (*) marks any calls received since the last time you checked the list. • In standby, all handsets show how many calls came in since the last time you checked the CID list. 	<ul style="list-style-type: none"> • Each handset remembers the last 10 numbers you dialed on it.

To...	Press...
open the CID list	MENU/OK (base/handset) and select <i>Recent Calls->Caller ID</i> .
open the redial list	MENU/OK (base) or REDIAL/PAUSE (handset) and select <i>Recent Calls->Redial</i> .
scroll through the lists	DOWN to scroll from newest to oldest. UP to scroll from oldest to newest.
dial the current number	TALK/FLASH or SPEAKER on the handset. Pick up the corded handset on the base.
close the lists	REPEAT  (base) or END/CLEAR (handset).

Once you display a CID or redial entry, you can delete it or add it to a phonebook. You can also add CID entries to a call block list, or delete all of them.

To...	Press...
delete the current number	MENU/OK , then select <i>Delete</i> .
add the current number to this station's phonebook.	MENU/OK , then select <i>Store Into PB</i> . The phone displays the <i>Edit Name</i> screen (see page 22).
add the current number to a call block list (CID only)	MENU/OK , then select <i>Add Call Block</i> . The phone displays the <i>Edit Name</i> screen (see page 27).
delete all the CID entries	MENU/OK , then select <i>Delete All</i> .

Deleting All Numbers in the CID List

Press **MENU/OK** and select *Recent Calls->Caller ID*. Select an entry, press **MENU/OK**, and then select *Delete All*. When the phone prompts you to confirm, select Yes.

Using Call Waiting

If you get a Call Waiting call, the phone sounds a tone and displays any CID information received for the waiting call.

For Australia

Press **TALK/FLASH** on the handset or (**FLASH** on the base) and then press **2** to accept the waiting call. The first caller is put on hold, and you will hear the new caller after a short pause. To return to the original caller, press **TALK/FLASH** on the handset or (**FLASH** on the base) and then **2** again.

For New Zealand:

Press **TALK/FLASH** on the handset or (**FLASH** on the base) to accept the waiting call. The first caller is put on hold, and you will hear the new caller after a short pause. To return to the original caller, press **TALK/FLASH** on the handset or (**FLASH** on the base) again.

To...	Press...
open the phonebook	PHONEBOOK  and select <i>Home</i> .
scroll through the entries	DOWN to scroll through the entries from A to Z. UP to scroll from Z to A.
jump to entries that start with a certain letter	the number key corresponding to the letter you want.
dial the current entry	TALK/FLASH or SPEAKER on the handset. SPEAKER or pick up the corded handset on the base.
edit the current entry	MENU/OK , then select <i>Edit</i> .
delete the current entry	the appropriate MENU/OK key until you have a list of options. Select <i>Delete</i> . To confirm, select <i>Yes</i> .

Using the Phonebook

The base can store up to 200 entries in its phonebook. All handsets share the same phonebook, so only one handset can access it at a time.

To...	Press...
open/close the phonebook	Press PHONEBOOK 
scroll through the entries	Press PHONEBOOK and then select either <i>Home</i> or <i>Speed Dial</i> . Select <i>Home</i> , then select the option <i>View Number</i> ; Use the following keys to scroll: DOWN to scroll through the entries from A to Z. UP to scroll from Z to A.
jump to entries that start with a certain letter	the number key corresponding to the letter you want.
dial the current entry	TALK/FLASH or SPEAKER .
edit the current entry	MENU/OK , then select <i>Edit</i> .
delete the current entry	MENU/OK , then select <i>Delete</i> . To confirm, select <i>Yes</i> .

Adding/Editing Phonebook Entries

To add a new phonebook entry (with the phone in standby), press **PHONEBOOK**.

Two options display on the screen, *Home* and *Speed Dial*.

Select the option *Home* and then select *Create New*. Enter a name and number, then select a personal ring.

To add the current number to the phonebook,

- press **MENU/OK** and select *Store into PB*. The *Edit Name* screen displays. Edit the information. Press **MENU/OK**.
- The *Edit Number* screen with the current number displays. Edit the phone number if you need to, otherwise press **MENU/OK**. If you need to edit the number, press **END/CLEAR** or **MUTE/DELETE** to back up the cursor and delete numbers. Re-enter the correct numbers. The *Personal Ring* screen displays. Select a ring then, press **MENU/OK** to save.
- If you need to enter a pause between the numbers, press **REDIAL/PAUSE**; you'll see **P** in the display. (The dialing will pause for about 3 seconds per digit.)

Deleting All the Phonebook Entries

With the phone in standby, press **PHONEBOOK**. Select the option *Home* and then select *Delete All*. To confirm, select *Yes*.

Chain Dialing

If you often have to enter a series of digits or a code number during a call, you can save that code number as a regular phonebook entry and use the phonebook to send the code number.

1. Make your call normally. When you hear the prompt that asks you to enter your code number, open the phonebook and find the entry.
2. Press **MENU/OK** to send the code. If you change your mind, just close the phonebook.

Speed Dial/3 Picture Keys

You can assign a name from phonebook to each dial keys from 0 to 9 on the base and the cordless handset. The base and the handset shares the same speed dial keys. When you assign names to dial keys 1 to 3 on the base unit or on the handset unit, they are also assigned to the base unit picture dial keys P1, P2 and P3 respectively.

Assigning Speed Dial

1. With the phone in standby, open the phonebook and select the option *Speed Dial*. The speed dial numbers correspond to the numbers (0 through 9) on the twelve key dial pad.
2. Select any number, depending on which key you want that particular contact number to correspond to, and press **MENU/OK**.
3. The options, *Registration* and *Delete*, display on the LCD.
4. Select the option, *Registration* and press **MENU/OK**.
5. Select the option, *Home* and press **MENU/OK** The phonebook for the handset and will display.
6. Select the relevant phonebook and choose the desired contact number. Press **MENU/OK** to review the number. Press **MENU/OK** again to save the entry.
 - Each speed dial number can be assigned to only one entry.
 - If the speed dial number is already assigned, the phone shows the name of the entry assigned to the number. If you want to change it, select the number, and the phone overwrites the existing assignment.

Using Speed Dial

1. With the phone in standby, on the base,
press **SPEAKER** or lift the corded handset and then press the relevant speed dial/ picture key to make a call. or
press and hold the speed dial/picture key till the relevant contact number displays on the screen, then either press **SPEAKER** or lift the corded handset.
2. With the phone in standby, on the cordless handset,
press and hold the desired number key till *Speed Dial* displays on the screen. When the relevant contact number displays on the screen, press **TALK/FLASH** or **SPEAKER** to make a call.

Removing Assigned Speed Dial

1. With the phone in standby, open the phonebook and select the option *Speed Dial*.
2. Select the name that you want to remove and press **MENU/OK**.
3. The options, *Registration* and *Delete*, display on the LCD.
4. Select the option, *Delete* and press **MENU/OK**.

HELP FEATURE

Emergency Call

Use the SSE 47 **HELP** feature to reach out to contacts of your choice in an emergency situation. Before you make the emergency call, you need to ensure that you have recorded an emergency message and updated the SOS contacts in your phonebook.

Record Emergency Message

You can record an emergency message on your SSE 47 base. This is the message that is heard by the other party, when they answer an emergency call. The maximum length of the message is 30 seconds. Ensure that your instructions are short and clear.

Follow the steps below to record an emergency message.

1. Press and hold **ON/OFF+DELETE** keys on the base till you hear a prompt asking you to record your message.
2. Speak your message in a loud and clear voice towards the front of the base. To stop recording, press **PLAY/STOP**. It's recommended that you add the instructions, "*to answer this call, press the hash key on your telephone*" to your personal message.
3. The base will automatically playback the recorded message after recording.
4. To return to standby state, wait till the playback ends or press **PLAY/STOP**.
5. If you press **DELETE** during playback, the Emergency Message will be deleted and the phone returns to the standby state.

Editing the SOS Entries in the Phonebook

You need to add the contact number to the SOS entries in your phonebook.

On the SSE47 Base/Handset.

1. Press **PHONEBOOK**. Select *Home* and press **MENU/OK**. The option, '*View Number*', '*Create New*', '*Delete All*', displays.
2. Select the option *View Number* and press **MENU/OK**. The phonebook entries display.
3. Scroll down, if needed, to select *SOS1* entry and press **OK**. *SOS1* entry displays.
4. Press **MENU/OK**. Select *Edit* and press **MENU/OK**. *Edit Name SOS1* displays.
5. Do not change the name. Press **MENU/OK**. *Edit Number* displays.
6. Enter the desired phone number and press **MENU/OK**.
7. The next settings are not required for emergency dial. Press **MENU/OK** to continue and save. *Saving and Done!* displays.

Repeat for *SOS2*, *SOS3*, *SOS4* and *SOS5* entries.

Creating New SOS Entries in the Phonebook

If no SOS entries are pre-stored in the phonebook then follow the steps above but select *Create New* at step 2 and name the entry *SOS1* and continue the steps to edit the number and save the entry.

- ☒ **If you enter less than 5 SOS numbers, for example, you add just one SOS number, the Pendant will call that one number 5 times. Or if you add 2 numbers, it will alternate between those two numbers till it completes 5 calls.**

Make an Emergency Call

1. Press and hold **HELP** for 2 seconds to activate it.

And after that?

2. The base will first dial out the first emergency number (stored in the SOS1 entry).
- a) As soon as the first emergency number is dialled, the pre-set emergency message will play, *“This is an emergency call, to accept press the # key on your telephone now.”* This message will be heard on the speaker and the outside line, and is repeated every 3 seconds. If a personal emergency message has been recorded, it will play that message first and then the pre-set message.
- b) If the first emergency number is not answered after 60 seconds, then the next emergency number is dialled. This is repeated, if necessary, until all 5 numbers have been dialled. When the outside line answers the call and presses the # key, then the microphone is activated and you can now talk through the base.

To end a call:

- Press and hold **HELP** for 2 seconds, or until you hear a beep tone to disconnect an emergency call.

USING SPECIAL FEATURES

Real Time Slow Talk

With the *Real Time Slow Talk* feature, you can listen to the other person's voice at a speed that is slower than normal.

1. During a conversation, press **SLOW** to slow down the speed of the other person's voice.
 2. Pressing **SLOW** again to return normal playback speed.
- ✎ **This feature is optimised to extend normal speech of a short nature - such as; "Welcome to Uniden" or "Please press 1".**
 - ✎ **The extension feature is not applied when the caller's speech is already slow, or the sentence spoken is long and continuous.**

Playback Slow Talk

1. During Playback, press **SLOW** to slow down the playback speed.
 2. Press **SLOW** again to return normal playback speed.
- ✎ **Slow Talk feature does not work during intercom and will deactivate after each call ends and when you stop playback.**

Using Caller Announce

With the Caller Announce feature, you can turn on Text To Speech so your phone can announce names in different situations.

- You have to turn on Caller Announce separately for each cordless handset (see page 16).
- To change the volume of CID announcements, change the ringer volume. To change the volume for all Caller Announce features, change the speaker volume.
- To make sure it doesn't interrupt a call or an intercom page, the phone only uses Caller Announce when it starts out in standby.
- It takes at least 2 rings for the phone to receive CID information and announce it. If the phone is answered before the end of the second ring, the phone won't announce the name of the caller.

Setting Caller Announce

1. Select *Caller Announce* through the *Base* or *Handset Setup* menus.
2. Select *On* or *Off*.

When you... (from standby)	The phone announces...
receive a call	the caller's name (if sent by a CID service)
dial a number	the phone number you dialed
open the phonebook, choose HOME , select the desired contact number and then press MENU/OK .	the name of the entry you are looking at.

Call Blocking

If you subscribe to Caller ID, you can save phone numbers to the call block list. When a call comes in, the phone compares the received phone number to the numbers on the call block list. If the phone number is on the list, the phone replaces the caller's name with *Call Blocked* and blocks the call.

The Call Block list holds 20 entries, and all the handsets share the same list. You can add entries, by selecting, *Add Call Block*, in the CID menu that displays after you have viewed the CID record or through the Call Blocking Menu (see below). (Only one handset can edit the Call Block list at a time).

With the Call Block PRO feature, you can register individual contact numbers or even certain digits, to block calls from those numbers. For example, if you register "02 9597 9" then all calls from contact numbers beginning with "02 9597 9" will be blocked. If you register "02 9597 9xxx" then all calls from that particular contact number will be blocked.

Call Blocking Menu Options

With the phone in standby, open the menu and select *Call Blocking*. Choose one of these options:

Menu Options	What it does
<i>View Number</i>	See the numbers on your call block list.
<i>Create New</i>	Add an entry to your call block list. The phone will prompt you to enter a name & phone number.
<i>Private Number</i>	Block all calls from numbers reported by CID as "Private." (This does not count as one of the 20 entries.)
<i>Unknown Number</i>	Block all calls from numbers reported by CID as "Unknown". (This does not count as one of the 20 entries.)

Call Blocking Entry Options

With the phone in standby, open the menu, select *Call Blocking* then *View Number*; scroll through the entries. Press **MENU/OK** to open the individual entry. Choose one of these options:

Choose this...	To...
<i>Edit</i>	Edit this entry. The phone will prompt you to edit the name & phone number.
<i>Delete</i>	Erase this entry from the list and allow calls from this number.

With the phone in standby, open the menu, select *Call Blocking*, then *Create New*. Enter the name and number to be blocked. Press **MENU/OK** to save the entry.

Adjusting the Base Visual Ringer

Visual Ringer

The visual ringer blinks for the following conditions:

- Incoming call - outside line
- Incoming call - intercom or intercom hold

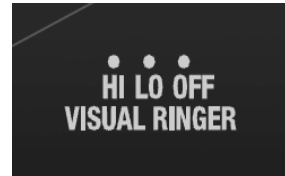

You can change the brightness of the base visual ringer. The **VISUAL RINGER** switch is on the right-hand side of the base. Slide the switch to HI, LOW, or OFF. (It doesn't affect the audio ringers.)

Using the Audio Boost

The Audio Boost feature enables you to increase the earpiece volume for normal and intercom calls.

1. During a call, press **BOOST**.

The **BOOST** icon is displayed on the screen.

2. Press **UP OR DOWN** repeatedly to increase or decrease the volume.

DND (Do Not Disturb) Mode

- You can silence the ringers on the base and all handsets at the same time. It doesn't affect the visual ringers.
- With the phone in standby, press and hold **#/DND**. The phone automatically turns on the answering system and shows *DND Mode On* in the display on each handset. (The answering system answers any incoming calls without playing anything through the speaker.)
- To cancel, press **#/DND** again.

🔇 **If you turn the answering system off while DND mode is on, the phone turns off DND mode.**

Using Multi-Handset Features

 To use the features in this section, you need at least 1 cordless handset.

Expanding Your Phone

- Your base supports a total of 6 cordless handsets, including any that came with your phone.
- You must register accessory handsets to the base before using them. Handsets that aren't registered display a *"not registered"* message. For registration instructions, see page 39 or the accessory handset manual.

Using Conference Calling

- When an outside call comes in, the base and two cordless handsets can join in a conference call with the outside caller.
- To join the call, just pick up the corded handset from the base or press **TALK/FLASH** on a cordless handset. To leave the conference call, hang up normally; the other station remains connected to the call.

Using Privacy Mode

- To activate Privacy Mode on a call in progress, select *Call Privacy* from the menus. As long as privacy mode is on, no other handsets can join your call.
- Privacy Mode turns off automatically when you hang up or put the call on hold.
- To use privacy mode during a conference call, wait until all stations have joined the call before turning on Privacy Mode. If a handset disconnects, that handset cannot rejoin the call as long as Privacy Mode remains on.

Call Transfer

To...	From the Base	From a cordless Handset
<i>transfer a call</i>	<ol style="list-style-type: none">1. Select <i>Hold/Transfer</i> from the menus.2. The system puts the call on hold. Select the handset you want to page, or <i>All</i> to page all handsets. <p>When the other handset accepts the call, you'll be disconnected, but you can join the call again.</p>	
<i>cancel a transfer</i>	Quickly press and release the hook switch.	Press TALK/FLASH to return to call.
<i>accept a transferred call</i>	To answer the page and speak to the transferring handset, pick up the corded handset.	TALK/FLASH to answer the page and speak to the other handset. Then press TALK/FLASH to speak to the caller.

Intercom

- Whenever the phone is in standby, you can make an intercom call between handsets without using the phone line.
- You can make an intercom call between BASE-HAND or HAND-HAND.
- If an outside call comes in during an intercom page, the phone cancels the page so you can answer the incoming call.
- If an outside call comes in during an intercom call, press **TALK/FLASH** to hang up the intercom call and answer the outside call.

To...	From the base	From a cordless handset
<i>make an intercom page</i>	3. Press INTERCOM/HOLD .	Select <i>Intercom</i> in the main menu.
	4. Select the station you want to talk with, or <i>All</i> to page all stations.	
<i>cancel a page</i>	Press INTERCOM/HOLD .	Press END/CLEAR .
<i>answer an intercom page</i>	Press INTERCOM/HOLD or pick up the corded handset.	Press TALK/FLASH .
<i>leave an intercom call</i>	Press INTERCOM/HOLD or place the corded handset in the cradle.	Press END/CLEAR or place the handset in the cradle.

Finding a Lost Handset

You can use the intercom page to find a lost handset. When the intercom tone sounds, you can track the tone to the lost handset.

Using Voice Message Notification

If you subscribe to a voice mail service, your phone can notify you when you have a new message. This feature supports Frequency-Shift Keying (FSK) notification.

The voice mail service provided by your service provider is independent from the built-in answer machine of the SSE47. Contact your voice mail provider for information.

- Depending on your telephone service provider, when you have new messages, you may be alerted in the following ways:
 - the display may show a message icon, (if your phone has an LCD display),
 - the dial tone will sound different (you will hear an interrupted dial tone), and/or
 - the charge LED on the cordless handset will flash (Flashing Message Indicator)
- After you listen to your messages, the message icon disappears, the dial tone returns to normal, and/or the charge LED on the cordless handset stops flashing. With the phone in standby, open the menu and select *Advanced Setup*; select *VMWI Reset*, then select *Yes*.

Using an Optional Headset

You can use a standard telephone headset (2.5mm diameter jack) with your handsets.

To purchase headsets, visit our website; **www.uniden.com.au**

- To install a headset, remove the headset jack cover and insert the headset plug into the jack.
- Just make and receive calls as usual, and use your headset to talk to the caller after the call connects.
- While you connect a headset, the handset automatically mutes the earpiece.

USING THE ANSWERING SYSTEM

Answering System Options (Answering Setup)

You can change the answering system options from any handset. Just open the menu and select *Answering Setup*.

Menu Options	What it does
<i>Security Code</i>	Enter a 2-digit PIN so you can access your answering system from any touch-tone phone (see page 35).
<i>Ring Time</i>	Set the number of rings (6, 9, or 12) before the system answers. If you have the Ring Time set to Toll Saver, the system answers after 2 rings if you have new messages and 4 rings if you don't. (see page 35 for more details).
<i>Record Time</i>	Set the amount of time (1 or 4 minutes) callers can leave a message. Choose <i>Announce Only</i> if you don't want the system to let callers leave a message.
<i>Message Alert</i>	Have the base beep every 15 seconds when you have a new message. The alert stops after you listen to all your new messages or if you press any key on the base.
<i>Call Screen</i>	Turn on the call screen feature so you can hear callers as they leave messages on the base speaker (see page 34).
<i>Answer On/Off</i>	Turn your answering system on or off. (To turn your system on or off from the base, just press ON/OFF .)
<i>Record Greeting</i>	Record an outgoing greeting (see page 33).
<i>Greeting Options</i>	Switch greetings or delete your greeting (see page 33).

Accessing the Answering System

With the phone in standby, you can access your system from the base or remotely from any handset. Only 1 handset or the base can access the system at a time.

During remote access;

- The system beeps so you know it's waiting for your next command.
 - You can press the number key shown next to each command instead of scrolling through the screens.
1. Press **MENU/OK** and select *Messages/Play Messages* to listen to your answering system messages. The LCD displays CID information for the current message.
 2. The LCD also displays actions you can take while the message is playing. Press the number on the keypad that corresponds to the action you want to take. If you stop the message, the LCD displays *2:Play* instead of *5:Stop*.

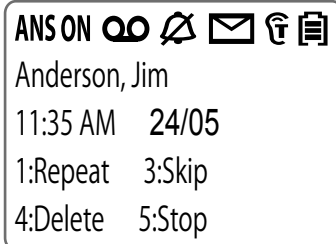

Recording Your Personal Greeting

Your personal outgoing message or greeting can be between 2 seconds and 30 seconds long. If you don't want to record a greeting, the system uses the pre-recorded greeting: *Hello, no one is available to take your call. Please leave a message after the tone.*

From the Base	From a Cordless Handset
<ol style="list-style-type: none">1. Open the menu and select <i>Answering Setup/Record Greeting</i>.2. Press MENU/OK, a message displays, <i>To Start, Press Ok</i>. Press MENU/OK. Wait until the system says, "Record greeting" before speaking.3. Press PLAY/STOP to stop recording. The system plays back your new greeting.4. To keep this greeting, press PLAY/STOP. To re-record it, go back to step 2.	<ol style="list-style-type: none">1. Access the <i>Answering Setup</i> menu and select <i>Record Greeting</i>.2. Press MENU/OK, a message displays, <i>To Start, Press Ok</i>. Press MENU/OK. Wait until the system prompts "Record greeting" before speaking.3. Press MENU/OK to stop recording. The system plays back your new greeting.4. To keep this greeting, press END/CLEAR. To re-record it, go back to step 2.

Switch Between Greetings

From the Base	From a Cordless Handset
<ol style="list-style-type: none">5. Open the menu and select <i>Answering Setup</i>. Then select <i>Greeting Options</i>.6. The system plays back the current greeting.7. Press MENU/OK to switch greetings.	<ol style="list-style-type: none">5. Press MENU/OK and select <i>Answering Setup/Greeting Options</i>.6. The current outgoing message plays.7. During playback, press MENU/OK to switch between the preset outgoing message and the message you created.

Delete Your Greeting

Switch to your personal greeting; press **DELETE** on the base or **MUTE/DELETE** on the handset while the greeting is playing.

Getting Your Messages

You can play back your messages from the base or from a cordless handset.

To..	From the Base	From the Handset
play new messages	Press PLAY/STOP .	Select <i>Messages/Play Messages</i> from the Main menu.
	The system announces the number of new and old messages, then plays each new message (followed by the day and time if set) in the order it was received.	
restart this message	Wait at least 5 seconds after the message starts playing,	
	Press REPEAT .	Select 1: <i>Repeat</i> .
replay an earlier message	Within 2 seconds after a message starts playing,	
	Press REPEAT .	Select 1: <i>Repeat</i> .
skip a message	Press SKIP .	Select 3: <i>Skip</i> .
slow down message playback	Press SLOW . Press again to return to normal playback speed.	Not available.
delete a message	While the message is playing,	
	press DELETE .	select 4: <i>Delete</i>
delete all messages	With the phone in standby, press DELETE ; press DELETE again to confirm.	Not available.
play old messages	After the system plays the new messages,	
	press PLAY/STOP again.	select 2: <i>Play</i> .
stop playback	Press PLAY/STOP .	Select 5: <i>Stop</i> .

Screening Your Calls

You can use the answering system for *call screening*. While the system takes a message, you can listen on the base speaker (if you turn on *Call Screen*) or from a cordless handset. Only one handset can screen calls at a time. If another handset tries to screen the call, it beeps and returns to standby.

To...	From the Base	From a Cordless Handset
turn on Call Screen	Press MENU/OK then select <i>Answering Setup/Call Screen</i> menu. Turn call screen on or off.	Press MENU/OK then select <i>Answering Setup/Call Screen</i> menu. Turn call screen on or off.
hear the caller leaving a message	Just listen to the caller over the speaker.	Press MENU/OK .
answer the call	Pick up the corded handset.	Press TALK/FLASH .

mute the call screen without answering	Press CLEAR/MUTE .	Press END/CLEAR or return the handset to the cradle.
--	---------------------------	---

☞ If you mute the call screen, the system continues taking the message: it just stops playing through the speaker.

Using the System While You're Away from Home

You can also operate your answering system from any touch-tone phone. Before you can use this feature, you have to program a security code.

Programming a Security Code

1. With the phone in standby, open the menu. Select *Answering Setup*, then select *Security Code*.
2. Use the number keypad to enter a two-digit security code (01 to 99). Press **MENU/OK** when you're finished.

☞ **Remember to make a note of your new security code!**

Dialing in to Your System

3. Call your telephone number and wait for the system to answer.
 - If you have the Ring Time set to Toll Saver, the system answers after 2 rings if you have new messages and 4 rings if you don't. You can hang up during the third ring.
 - If your answering system is off, it will answer after about 15 rings and sound a series of beeps instead of your greeting.
4. During the greeting (or beeps), press # and immediately enter your security code. (If you enter it incorrectly 3 times, the system hangs up and returns to standby.)
5. The system announces the time, the number of messages in memory, and a help prompt. It beeps intermittently to let you know it's waiting for a command.
6. When you hear beeping, enter a 2-digit command from the chart:

#1	Repeat message	#5	Stop playback
#2	Play message	#6	Turn the system on
#3	Skip message	#9	Turn the system off
#4	Delete message	#0	Hear help prompts

☞ If you don't press any keys for 15 seconds, the phone will hang up and return to standby.

REMINDER SETUP

Reminder Messages

You can record messages and set reminders to them. After you record a message, set the date and time, and the base will playback the recorded message at the set time.

You can set up to three reminder messages. You can set reminders once (one-off) or on a daily/weekly basis.

With the phone on standby, press **MENU/OK** and select *Reminder Setup*.

1. In Reminder Setup menu, there are three reminders that can be set, *Reminder-1* to *Reminder-3*. Select your preferred reminder number and then press **MENU/OK**.
2. There are three reminder options - once/daily/weekly. Select the option that suits your need and press **MENU/OK**.
When *ONCE* is selected, it will prompt you to enter date and time setting,
When *DAILY* is selected, it will prompt you to enter time setting,
When *WEEKLY* is selected, it will prompt you to select the day of the week, and time setting.
3. Press **MENU/OK** to save date and time.
4. Press **MENU/OK** to start recording the reminder message. Press **MUTE/DELETE** to skip this step. Your recording can be between two to 30 seconds long.
5. Press **MENU/OK** to stop recording. The system will start playing the recorded reminder message. It will then return to the *Reminder Setup* menu.

Turn Off Message Reminder

1. Press **MENU/OK** when the phone is on standby and scroll down to select *Reminder Setup* and press **MENU/OK**.
2. In *Reminder Setup* menu, select the reminder that you want to switch off and then press **MENU/OK**.
3. Select *OFF* and press **MENU/OK** to confirm selection.

IMPORTANT INFORMATION

Solving Problems

If you have any trouble with your phone, check this section first. If you need help, visit the customer support page of our website listed on the front cover.

General Problems	Possible Solutions
No handsets can make or receive calls.	<ul style="list-style-type: none"> • Check the telephone cord connection. • Disconnect the base AC adaptor for a few minutes; then reconnect it.
A handset can't make or receive calls.	<ul style="list-style-type: none"> • Move the handset closer to the base.
The corded handset can make calls but the cordless handset(s) cannot.	<ul style="list-style-type: none"> • Check the power connection to the base. If the base is unplugged or the power goes out, only the corded handset can make and receive calls.
A handset can make calls, but it won't ring.	<ul style="list-style-type: none"> • Make sure the ringer is turned on. • Make sure DND Mode is turned off (see page 28).
A handset is not working.	<ul style="list-style-type: none"> • Charge the battery for 15-20 hours. • Check the battery connection.
The phone keeps ringing when I answer on an extension.	<ul style="list-style-type: none"> • You may have to change the line mode. Contact Customer Service for instructions.
Audio Issues	Possible Solutions
Callers sound weak or soft.	<ul style="list-style-type: none"> • Move the handset closer to the base. • Keep the handset's battery fully charged. • Increase the earpiece volume.
There's a lot of noise or static on the line	<ul style="list-style-type: none"> • Check for interference from appliances (microwave ovens, TVs, etc.) or wireless devices (baby monitors, WiFi equipment, etc.). Move the handset or base away from the interference source. • Try to adjust the audio tone. During a call, press TONE to cycle through the three audio tone options: Low Tone, Natural Tone (recommended for hearing aid users), or High Tone. (The tone setting appears in the display as you do this.) • If you use a telecoil hearing aid, turn on T-coil mode (see page 16). • If you have any service that uses the phone line, add a DSL or telephone line filter (see page 39).

Caller ID Problems	Possible Solutions
Caller ID information does not display.	<ul style="list-style-type: none"> • Let calls ring twice before answering. • Make sure your Caller ID service is active.
Caller ID displays briefly and then clears.	<ul style="list-style-type: none"> • You may have to change the line mode. Contact Customer Service for instructions.
Caller ID displays, but I can't hear the CID announcements.	<ul style="list-style-type: none"> • Making sure Caller Announce is turned on (see page 26). • Increasing the ringer volume so the CID announcements are louder.
Multi-handset Problems	Possible Solutions
I can't transfer calls.	<ul style="list-style-type: none"> • Reset all the handsets (see page 39).
Two handsets can't talk to a caller.	<ul style="list-style-type: none"> • See if any handset is in Privacy Mode.
A handset says <i>Unavailable</i> .	<ul style="list-style-type: none"> • Move the handset closer to the base. • See if any handset is in Privacy Mode. • Reset the handset (see page 39).
I can't register a new handset.	<ul style="list-style-type: none"> • Reset the handset (see page 39). • See if you have 6 registered handsets.
Answering System Problems	Possible Solutions
The answering system does not work.	<ul style="list-style-type: none"> • Make sure the answering system is on. • Make sure the base is plugged in.
The system won't record messages.	<ul style="list-style-type: none"> • See if Record Time is set to <i>Announce Only</i>. • Delete messages (memory may be full). • Set the answer machine ring time to 6 or less to ensure that the messages are not going to voice mail.
A handset can't access the answering system.	<ul style="list-style-type: none"> • See if another handset is using the system. • Make sure the phone is in standby.
My outgoing message is gone.	<ul style="list-style-type: none"> • If there was a power failure, re-record your personal outgoing message.
I can't hear the base speaker.	<ul style="list-style-type: none"> • Make sure call screening is turned on. • Change the base speaker volume.
Messages are incomplete.	<ul style="list-style-type: none"> • Increase the Record Time. • Delete messages (memory full)
The system keeps recording when I answer on an extension.	<ul style="list-style-type: none"> • You may have to change the line mode. Contact Customer Service for instructions.

Installing a Line Filter or DSL Filter

A telephone line filter or DSL filter prevents services that use the phone line from causing interference on your phone. To get a line filter, contact your service provider or look in an electronics store.

Plug the filter into the telephone wall jack and plug the base into the filter. Make a test call to make sure the noise is gone.

Liquid Damage

CAUTION: If the base is covered in liquid, disconnect the adaptor and phone cord from the wall before touching it.

If the liquid is only on the exterior housing of the base or handset, wipe it off and use as normal. If you can hear liquid inside the housing:

1. Disconnect all cables and cords and remove all compartment covers.
2. If liquid is leaking from any vent or hole, turn the phone so that vent faces down. If not, place the largest vent face down.
3. Let dry for at least 3 days. Check for liquid inside the phone before replacing compartment covers and reconnecting cords.

Resetting Base/Handset

If you have trouble with the base, unplug the base to reset it. Plug it back in after at least a minute.

If you have trouble with a cordless handset or if you want to replace one, reset it:

1. Press and hold **END/CLEAR** and **#** at the same time until *System Reset* displays (about 5 seconds).
2. If you still have the base the handset is registered to, select *Deregister HS*, then select the handset you want to reset. If you don't have that base anymore, select *Base Unavailable*.
3. To confirm, select *Yes*. The handset displays *Handset not registered*.

Registering a Handset

If you see a “*not registered*” message on a handset, you must register it to a base before using it.

1. On the base, open the menu and select *Register Accy*.
2. On the handset, press and hold **#/DND** until the handset display says *Handset Registering* (about 2 seconds).
3. Wait until the handset display shows, *Registration Complete* (about 30 seconds), then pick up the handset.

☞ **If you don't hear a dial tone or the display says *Registration Failed*, charge the battery completely, then try again.**

Adaptor and Battery Information

AC Adaptor	Base	Charger
Part number	AAD-041S(R)	AAD-600S(R)
Input voltage	100-240V AC, 50/60Hz	100-240V AC, 50/60Hz
Output voltage	9V DC @ 350mA	9V DC @ 210mA

- Use only the supplied AC adaptors.
- Use the proper adaptor for the base and any chargers.
- Do not place the unit in direct sunlight or subject it to high temperatures.

Battery Pack with Normal Use	
Part number	BT-694, BT-694s or BT-694n
Capacity	650mAh (BT-694) or 500mAh (BT-694s) or 400mAh (BT-694n)
Talk time	about 10 hours
Standby time	about 7 days
Battery life	about 1 year

- Replace the battery when the talk or standby time becomes noticeably reduced. For replacements, visit the online shop on our website (see the front cover).
- When the battery gets low, the handset beeps and shows a low battery alert; put the handset in the cradle for recharging.

Rechargeable Battery Warning

- This equipment contains a rechargeable Nickel-Metal-Hydrate (Ni-MH) battery.
- Do not short-circuit the battery.
- The batteries in this equipment may explode if disposed of in a fire.
- Do not charge the batteries in any charger other than the one specified in the owner's manual. Using another charger may damage the battery or cause it to explode.

Rechargeable batteries must be recycled or disposed of properly.

Uniden works to reduce lead content in our products and accessories.

INDEX

A

Answer Machine 32
Any Key Answer 16
Auto Talk 16

B

Banner 16
Battery 40
Boost 28

C

Call Block 27
Caller ID 20
Call Transfer 29
Call Waiting 21
Chain Dialing 22
Conference Calling 29

D

Date & Time 17
Do Not Disturb (DND) 28

E

Earpiece Volume 13, 28

H

Headset 31

I

Intercom 30

K

Key Touch Tone 16

L

LCD Contrast 16
Line Conference 29
Line Filter 39
Liquid Damage 39

M

Multihandset Feature 29
Mute 13

N

Noise 37

P

Paging Handsets 30
Personal Ring 16
Phonebook 22
Privacy Mode 29

R

Register the handset 39
Resetting the Handset 39
Ringer 16
Ringer Volume 13

S

Static 37

V

Voice Mail 30

W

Warranty 42

ONE-YEAR LIMITED WARRANTY

XDECT SSE47

IMPORTANT Satisfactory evidence of the original purchase is required for warranty service

Please refer to our Uniden website for any details or warranty durations offered in addition to those contained below.

Warrantor

The warrantor is Uniden Australia Pty Limited ABN 58 001 865 498 (“Uniden Aust”).

Terms of Warranty

Uniden Aust warrants to the original retail purchaser only that the SSE47 (“the Product”), will be free from defects in materials and craftsmanship for the duration of the warranty period, subject to the limitations and exclusions set out below.

Warranty Period

This warranty to the original retail purchaser is only valid in the original country of purchase for a Product first purchased either in Australia or New Zealand and will expire one (1) year from the date of the original retail sale.

If a warranty claim is made, this warranty will not apply if the Product is found by Uniden to be:

- (A) Damaged or not maintained in a reasonable manner or as recommended in the relevant Uniden Owner’s Manual;
- (B) Modified, altered or used as part of any conversion kits, subassemblies or any configurations not sold by Uniden Aust;
- (C) Improperly installed contrary to instructions contained in the relevant Owner’s Manual
- (D) Repaired by someone other than an authorized Uniden Repair Agent in relation to a defect or malfunction covered by this warranty; or
- (E) Used in conjunction with any equipment, parts or a system not manufactured by Uniden.

Parts Covered

This warranty covers the Product and included accessories.

User-generated Data

This warranty does not cover any claimed loss of or damage to user-generated data (including but without limitation phone numbers, addresses and images) that may be stored on your Product.

Statement of Remedy

If the Product is found not to conform to this warranty as stated above, the Warrantor, at its discretion, will either repair the defect or replace the Product without any charge for parts or service. This warranty does not include any reimbursement or payment of any consequential damages claimed to arise from a Product's failure to comply with the warranty.

Our goods come with guarantees that cannot be excluded under the Australian Consumer Law. You are entitled to a replacement or refund for a major failure and for compensation for any other reasonably foreseeable loss or damage. You are also entitled to have the goods repaired or replaced if the goods fail to be of acceptable quality and the failure does not amount to a major failure.

This warranty is in addition to and sits alongside your rights under either the COMPETITION AND CONSUMER ACT 2010 (Australia) or the CONSUMER GUARANTEES ACT (New Zealand) as the case may be, none of which can be excluded.

Procedure for Obtaining Warranty Service

Depending on the country in which the Product was first purchased, if you believe that your Product does not conform with this warranty, you should deliver the Product, together with satisfactory evidence of your original purchase (such as a legible copy of the sales docket) to Uniden. Please refer to the Uniden website for address details. You should contact Uniden regarding any compensation that may be payable for your expenses incurred in making a warranty claim. Prior to delivery, we recommend that you make a backup copy of any phone numbers, images or other data stored on your Product, in case it is lost or damaged during warranty service.

UNIDEN AUSTRALIA PTY LTD

Phone number: 1300 366 895

Email address: custservice@uniden.com.au

Uniden®

©2017 Uniden Australia Pty Ltd
Printed in Vietnam U01UN646EZZ(0)